

REFRIGERATOR INSTALLATION

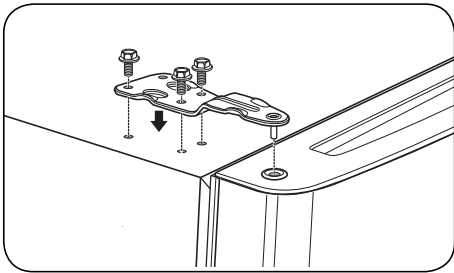

Tighten the bolts. Force-fit Top Hinge Cover over Top Hinge.

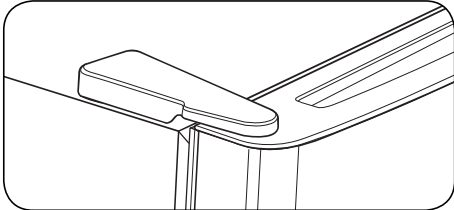

Replace cover on the top left side of the refrigerator to the right top to cover the holes. Cover is also force-fitted.

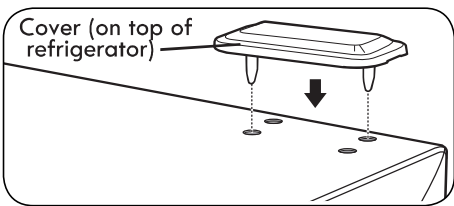

After changing doors, make sure that the corners of the Door Gaskets are not folded over. To ensure a good seal, apply a small amount of silicon grease on the corners of gaskets.

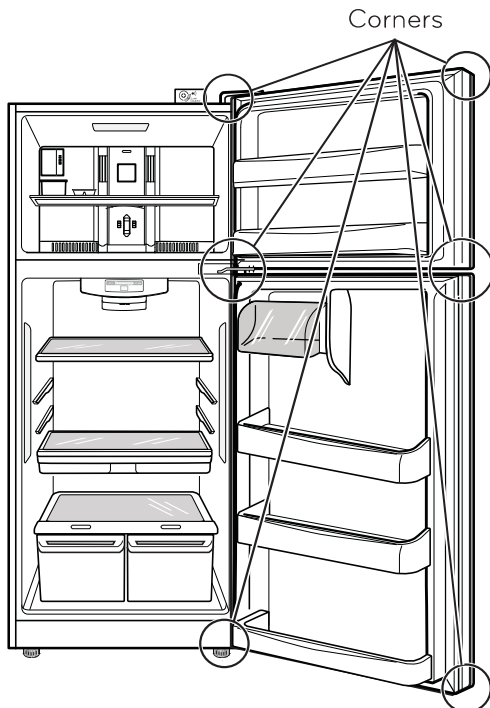

CLOSING AND ALIGNING THE DOORS

To avoid vibration, the unit must be leveled. If necessary, adjust the Leveling Legs to compensate for unevenness of the floor. The front should be slightly higher than the rear to aid in door closing.

Your refrigerator has three front leveling screws, one on the right and one on the left. If your refrigerator seems unstable or if you would like the doors to close more easily, simply adjust the inclination of the refrigerator by following the instructions below:

NOTE: Third leveling screw is used for protection of hinge lower.

1. Plug the refrigerator into a 3 prong grounded outlet. Move the refrigerator into its final position.
2. Use a 11/16" (18 mm) wrench or an adjustable wrench to adjust the leveling screws (see Figure A), turning clockwise to raise the side of the refrigerator and counter-clockwise to lower it. It may take several turns to adjust it to the inclination you would like.

NOTE: Having someone push against the top of the refrigerator takes some weight off the leveling legs. This will make it easier to adjust the level.

3. Open both doors again and check to make sure that they close easily. If not, tilt the refrigerator slightly more to the rear by turning both Leveling Screws clockwise. It may take several more turns, and you should turn both Leveling Screws the same times.

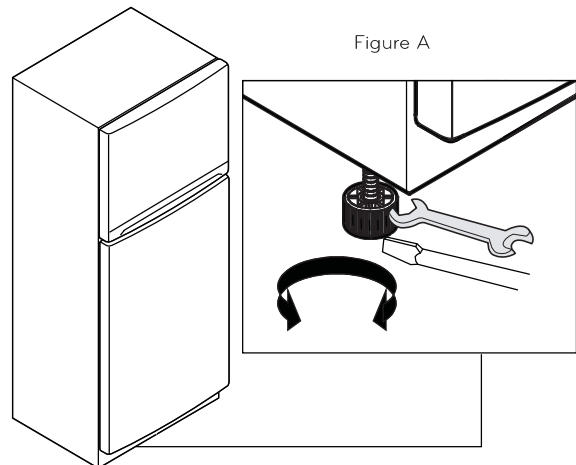

Door Alignment

If the space between your doors is uneven, follow the instructions below to align the doors:

1. Gently pry off the Top Hinge Cover with a flat head screwdriver and remove.
2. Loosen the Top Hinge Bolts using a 10 mm or 13/32 inch socket wrench or open-end wrench.
3. Have someone hold the freezer door so the space between the two doors is even, and retighten the top hinge bolts.
4. Replace the Top Hinge Cover.

USING YOUR REFRIGERATOR

ENSURING PROPER AIR CIRCULATION

In order to obtain stable temperature, the air must flow between the freezer and refrigerator sections. As shown in the illustration below, the cold air enters through the bottom part and circulates upward. This air returns below the freezer floor and the rest of the air enters the refrigerator section through the top vent.

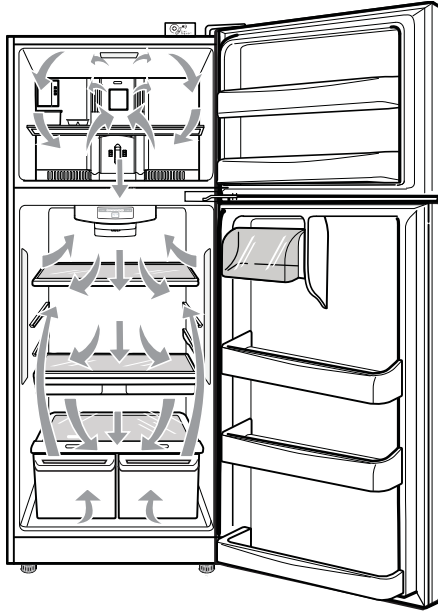

Do not block any of these vents with packages of food. This can interrupt the flow of air and cause temperature and moisture problems.

IMPORTANT: Because air circulates between both sections, any odors formed in one section will transfer to the other. You must thoroughly clean both sections to eliminate odors. To prevent odor transfer and drying out of food, make sure you wrap or cover foods tightly. (See the **"Food Storage Guide"** section for details).

NOTE: If you close the fresh food compartment door applying more force than necessary, freezer door may get open and close again, due internal air flow of refrigerator.

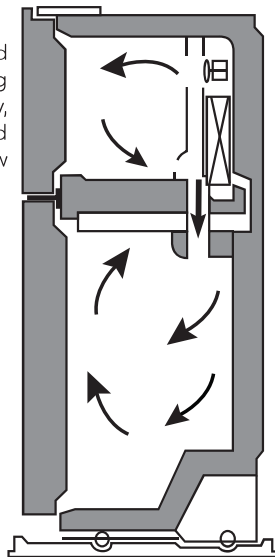

ADJUSTING THE CONTROLS

- Your refrigerator has two controls that allow you to regulate the temperature the freezer and refrigerator compartments.

• Refrigerator Control (On Some Models)

Initially set the Refrigerator Control on the middle setting (number 3). To do so, press the TEMPERATURE ADJUST button until it reaches the middle position (the third LED turns ON). Leave the refrigerator on this setting for 24 hours to reach the correct temperature. After 24 hours, adjust the compartment temperature as you desire. ALWAYS wait 24 hours before you adjust the temperature. If you want to set the refrigerator compartment temperature to a warmer temperature than the current, continue pressing the TEMPERATURE ADJUST button until it reaches the desired temperature.

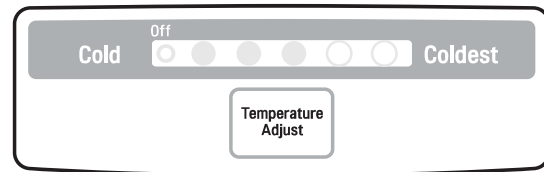

• Demo Mode (For Store Use Only)

Demo Mode disables all cooling in the refrigerator and freezer sections to conserve energy while on display in a retail store. When activated, OFF will display on the control panel.

To deactivate:

Press the TEMPERATURE ADJUST button until your desired temperature setting is reached. The OFF light will turn off once the Demo Mode is deactivated.

• Freezer Control

The freezer control should come from factory on the middle setting (number 3). Wait 24 hours before adjusting the freezer compartment temperature. Roll the knob to set the freezer temperature as you desire. ALWAYS wait 24 hours after any adjustment to reach the desired temperature.

NOTE: Setting at higher number of the freezer compartment, the temperature of freezer compartment becomes colder.

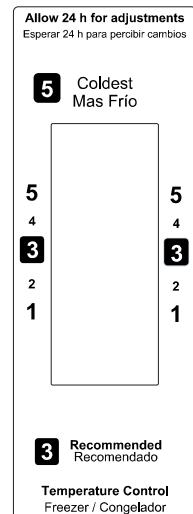

USING YOUR REFRIGERATOR

ADJUSTING CONTROL SETTINGS

Give the refrigerator time to cool down completely before adding food. It is best to wait 24 hours before adding food to the refrigerator. The mid-settings indicated in the previous section should be correct for normal household refrigerator usage. The controls are set correctly when milk or juice is cold to your liking and ice cream is firm.

The refrigerator control functions as the thermostat for the entire appliance. The higher the number setting, the longer the compressor will run to keep the temperature colder. The freezer control adjusts the cold air flow from the freezer to the refrigerator. Setting the freezer control to a lower temperature keeps more cold air in the freezer compartment to make it colder.

If you need to adjust the temperature in the refrigerator or freezer, begin by adjusting the refrigerator first. Wait 24 hours after the refrigerator adjustment to check the freezer temperature. If it is too warm or too cold, then adjust the freezer control as well.

Use the settings listed in the table below as a guide.

CONDITION/REASON:	RECOMMENDED ADJUSTMENT:
REFRIGERATOR section is too warm <ul style="list-style-type: none"> • Opening the door often • Adding a large amount of food • Room temperature is very warm 	Adjust the REFRIGERATOR setting to the next highest number and wait 24 hours, then check.
FREEZER section is too warm/ ice is made too slowly <ul style="list-style-type: none"> • Opening the door often • Adding a large amount of food • Room temperature is very low (not cycling often enough) • Using ice frequently • Air vents blocked by objects 	Adjust the FREEZER setting to the next highest number and wait 24 hours, then check. Remove any objects blocking air flow.
REFRIGERATOR section is too cold <ul style="list-style-type: none"> • Controls not set correctly for your conditions 	Adjust the REFRIGERATOR setting to the next lowest number and wait 24 hours, then check.
FREEZER section is too cold <ul style="list-style-type: none"> • Controls not set correctly for your conditions 	Adjust the FREEZER setting to the next lowest number and wait 24 hours, then check.

FOOD STORAGE GUIDE

ITEMS	HOW TO STORE
Storing Fresh Food	Wrap or store food in the refrigerator in airtight and moisture-proof material unless otherwise noted. This prevents food odor and taste transfer throughout the refrigerator. For dated products, check date code to ensure freshness.
Butter or margarine	Store opened butter in a covered dish or in a closed compartment. When storing a larger quantity, wrap in freezer packing and freeze.
Cheese	Store in original packaging until you are ready to use it. Once opened, tightly rewrap with plastic wrap or aluminum foil.
Vegetables with skins (carrots, peppers)	Place in bags or plastic containers inside the crisper.
Fruit	Wash and let dry; store in plastic bags in the refrigerator. Do not wash or pit berries until you are ready to eat them. Berries should be selected and kept in their original packaging (if there is any) or in a paper bag closed halfway and set on a shelf.
Leafy Vegetables	Remove original packaging and trim any dirty or discolored parts. Wash in cold water and drain. Place in a plastic bag or plastic container and store in the crisper.
Fish	Consume fish or seafood the same day purchased.
Chef Fresh	Store any meat in original airtight, moisture-proof packaging. Rewrap if necessary.
Leftovers	Cover leftovers with plastic wrap or aluminum foil. Plastic containers with airtight lids can also be used.

USING YOUR REFRIGERATOR

Packaging Recommendations:

- Use sealed plastic containers.
- Use plastic containers with a smooth surface.
- Package with aluminum foil of high resistance.
- Wrap with paper layered with plastic.
- Use water proof plastic.
- Use recommended plastic bags to store frozen foods.

Follow these packaging or container instructions in order to reach the best freezing

Do not use:

- Bread Wrapping.
- Plastic container not safe for storing.
- Containers without lids or seals.
- Waxed paper or waxed plastic.
- Thin wrapping paper or not water proof.

Freezing

IMPORTANT: Do not keep bottles in the freezer compartment, they may explode after freezing and cause damage.

For the maximum use of your freezer do not store excess food. Do not introduce a large amount of unfrozen foods that cannot be frozen within 24 hours (no more than 2 - 3 pounds or ,91 kg - 1,36 kg of food per square inch of space in the freezer). Sufficient space must be left in order for the air to circulate properly around the packages. Leave enough space in order to close your refrigerator with out difficulty.

Storage times can vary depending on the type and quality of the food, the way its package, or packaging container used, (in comparison to air and humidity), and the temperature it being stored in. Ice crystals formed inside your package are normal it indicates the air and humidity inside your package have condensed.

NOTE: Let warm foods cool off at room temperature for approximately 30 min, then wrap accordingly with the methods mention above and freeze. By letting your warm foods cool off before you introduce them to your freezer it will save you energy.

⚠ WARNING

SUFFOCATING DANGER

Adequate ventilation is required when using dry ice. Dry ice is Carbon Dioxide (CO₂). When it evaporates it produces oxygen, causing dizziness, slight headaches, unconsciousness or death. Do not inhale these vapors and properly ventilate the room while in use of dry ice.

REFRIGERATOR SHELVES

The glass shelves in your refrigerator are adjustable to meet your individual storage needs.

Adjusting the shelves to fit different heights of items will make finding the exact item you want easier. Doing so will also reduce the amount of time the refrigerator door is open which will save energy.

IMPORTANT: Do not clean glass shelves with warm water while they are cold. Shelves may break if exposed to sudden temperature changes or impact.

NOTE: Glass shelves are heavy. Use special care when removing them.

Adjusting Shelves

Remove shelves from the shipping position and replace shelves in the position you want.

To remove a shelf—Tilt up the back of the shelf in the direction of 1 and lift it in the direction of 2 . Pull the shelf out.

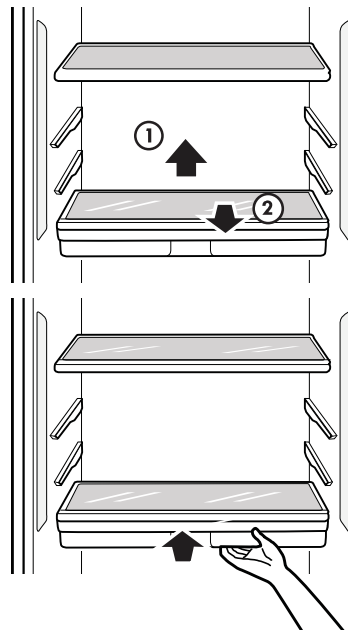

To reinstall a shelf—Slide the shelf into the guides until it stops.

PANTRY DRAWER (on some models)

To remove the Pantry Drawer:

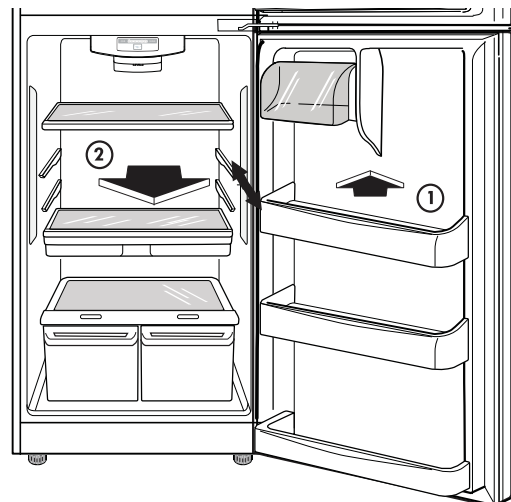

USING YOUR REFRIGERATOR

Grasp the drawer handle and pull it forward to the drawer stop. Lift up and pull out.

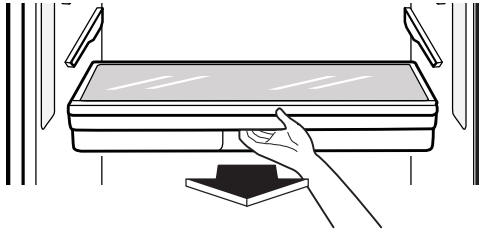

To replace the Pantry Drawer:

Slide the drawer back all the way past the drawer stop.

Ice Tray (On some models)

- Pour potable water to the level indicated in the picture. Do not overfill with water or ice cubes will be difficult to remove
- For quick freeze, adjust the freezer dial to 3.

Twist the ice tray to remove the ice cubes

- Do not bend the ice tray. Doing so may result in damage to the tray.
- To remove ice cubes easily, pour water on the back of the tray or soak it in water before removing ice cubes.



HUMIDITY CONTROLLED CRISPERS

The crispers provide fresher tasting fruit and vegetables by letting you easily control humidity inside the drawer.

You can control the amount of humidity in the moisturesealed crispers by adjusting the control to any setting between **VEGETABLES** and **FRUIT**.

- **VEGETABLES** keeps moist air in the crisper for best storage of fresh, leafy vegetables.
- **FRUIT** lets moist air out of the crisper for best storage of fruit.

To remove and install the crisper drawers:

1. Pull the crisper drawer out to the drawer stop.
2. Lift the front of the crisper up, then pull it straight out.
3. To install, slightly tilt up the front, insert the drawer into the frame and push it back into place, past the drawer stop.

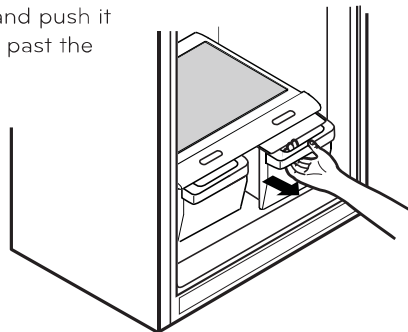

To remove the crisper glass:

1. Remove the crisper drawers (as described above).
2. Reach in under the glass and lift up.
3. Gently push the glass up and out.

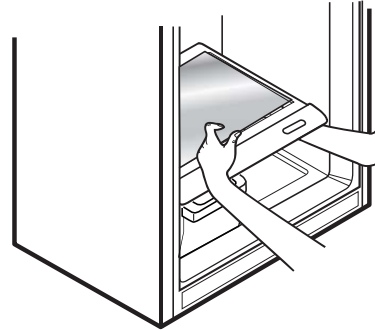

To remove the crisper cover:

1. Remove both crisper drawers.
2. Remove the crisper glass.
3. While holding the support and crisper cover, pull up and out.

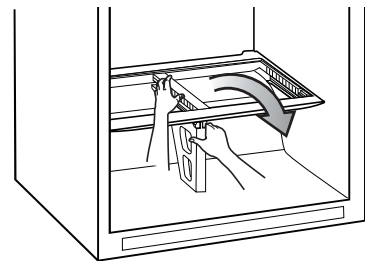

DOOR BINS

The door bins are removable for easy cleaning and adjustment.

1. To remove the bin, simply lift the bin up and pull straight out.
2. To replace the bin, slide it in above the desired support and push down until it snaps into place.

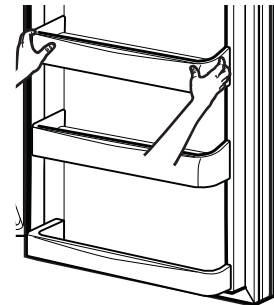

NOTE: Some bins may vary in appearance and will only fit in one location.

DAIRY BIN

1. To remove the Dairy Bin, simply lift up and pull out.
2. To replace the Dairy Bin, slide it in above the desired support slots and push down until it stops.

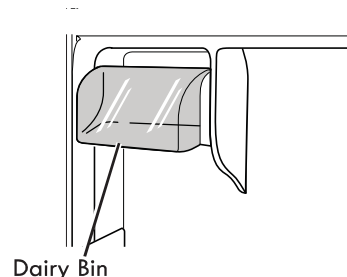

Dairy Bin

USING YOUR REFRIGERATOR

WATER DISPENSER (On some models)

To dispense cold water, push on the dispenser switch with a glass.

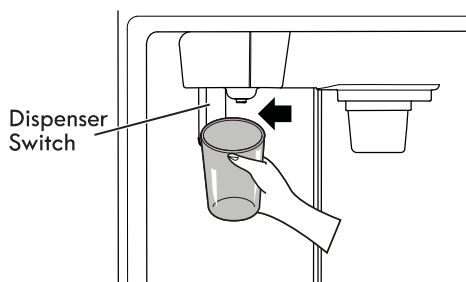

Some dripping may occur after dispensing. Hold your cup beneath the dispenser for a few seconds after dispensing to catch all of the drops.

⚠ WARNING: Do not put your fingers up the ice chute opening. Doing so can result in severe injury.

⚠ CAUTION: Do not dispense ice into fine china or crystal glasses. China or crystal can break.

AUTOMATIC ICEMAKER (on some models)

The icemaker will produce approximately 100-130 cubes in a 24-hour period, depending on freezer compartment temperature, room temperature, number of door openings and other operating conditions.

- It takes about 12 to 24 hours for a newly installed refrigerator to begin making ice. Wait 72 hours for full ice production to occur.
- Ice making stops when the bin fills to the level of the feeler arm.
- To turn off the automatic icemaker, set the icemaker switch to **OFF (O)**. To turn on the automatic icemaker, set the switch to **ON (I)**.
- The water pressure must be between 20 and 120 psi on models without a water filter and between 40 and 120 psi on models with a water filter to produce the normal amount and size of ice cubes.

⚠ CAUTION:

- Throw away the first few batches of ice (about 24 cubes). This is also necessary if the refrigerator has not been used for a long time.
- Never store beverage cans or other items in the ice bin for the purpose of rapid cooling. Doing so may damage the icemaker or the containers may burst.
- Never use thin crystal glass or crockery to collect ice. Such containers may chip or break resulting in glass fragments in the ice.

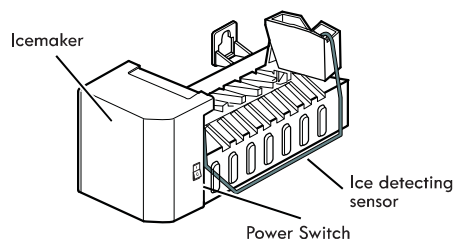

WHEN YOU SHOULD SET THE ICEMAKER POWER SWITCH TO OFF (O)

- When the water supply will be shut off for several hours.
- When the ice bin is removed for more than one or two minutes.
- When the refrigerator will not be used for several days.

NOTE: The ice bin should be emptied when the icemaker ON/OFF switch is turned to the OFF position.

NORMAL SOUNDS YOU MAY HEAR

- The icemaker water valve will buzz as the icemaker fills with water. If the power switch is in the **ON (I)** position, it will buzz even if it has not yet been hooked up to water. To stop the buzzing, move the power switch to **OFF (O)**.

NOTE: Keeping the power switch in the ON (I) position before the water line is connected can damage the icemaker.

- You will hear the sound of cubes dropping into the bin and water running in the pipes as the icemaker refills.

PREPARING FOR VACATION

Set the icemaker power switch to OFF (O) and shut off the water supply to the refrigerator.

NOTE: The ice bin should be emptied anytime the icemaker ON/OFF switch is turned to the OFF (O) position.

If the ambient temperature will drop below freezing, have a qualified technician drain the water supply system to prevent serious property damage due to flooding caused by ruptured water lines or connections.

⚠ WARNING

Personal Injury Hazard

DO NOT place fingers or hands on the automatic ice making mechanism while the refrigerator is plugged in.

WATER FILTER

WATER FILTER (On some models)

It is recommended that you replace the water filter.

- Approximately every 6 months.
- When the Filter Exchange indicator turns on.
- When the water dispenser output decreases.
- When the ice cubes are smaller than normal.

REMOVE THE OLD WATER FILTER.

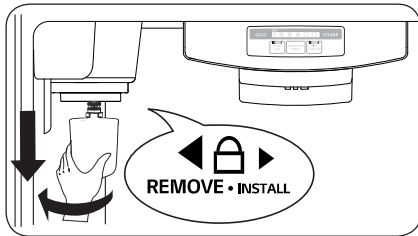

NOTE: Replacing the water filter causes a small amount of water (around 1 oz. or 25 cc) to drain. Wrap a cloth around the front end of the water filter cover to collect any water. Hold the water filter upright, once it is removed, to prevent any remaining water from spilling out of the water filter.

1. Make sure to turn off the household water supply.
2. Turn the filter counterclockwise and then pull down and out. Make sure to rotate the filter down completely before pulling it out of the manifold hole.

NOTE: The substitute cap must be retained for the future. If the filter is removed and not replaced, it is necessary to reinstall the substitute cap to prevent water leaks from the filter housing.

REPLACE WITH A NEW WATER FILTER

1. Remove the red cap from the filter.

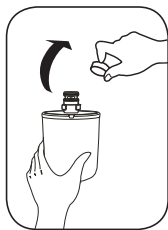

2. Insert the filter into the filter receptacle on the left side of the refrigerator compartment.

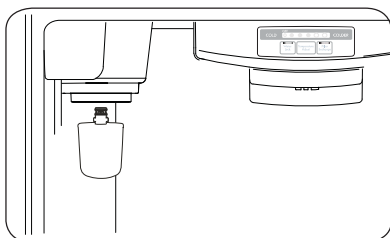

3. Push the water filter up into the filter receptacle and rotate it clockwise to lock it into place. Once installed correctly, you should not be able to rotate the filter clockwise any more.

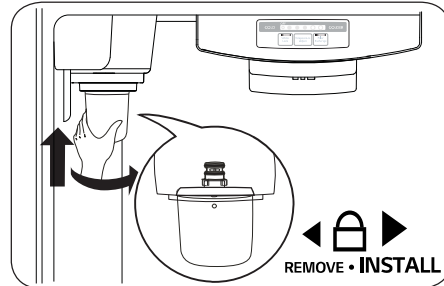

AFTER INSTALLING THE WATER FILTER:

1. Replace the shelf to the initial position.
2. Turn on household water supply.
3. Dispense 2.5 gallons (9.46 liters) of water to purge the system, depressing and releasing the dispenser pad in cycles of 30 seconds ON and 60 seconds OFF. Open the refrigerator door and check the shelf area for water leaks.

Replacement Filter: ADQ72910906.

REFRIGERATOR CARE AND CLEANING

⚠ WARNING

EXPLOSION HAZARD



Do not use flammable cleaners. Not following these instructions can cause death, explosion or fire.

The refrigerator, as well as the freezer, do their own de-freezing. This process does not prevent the build up of contaminants, therefore it is suggested that you clean both parts once a month; clean spilled liquids immediately.

REFRIGERATOR CLEANING

- Unplug your refrigerator.
- Pull out all of the removable parts (such as the vegetable and dairy doors).
- Use a clean sponge (or a soft rag) and use it with lukewarm water mixed with detergent. Do not use abrasive or concentrated cleaners.
- Hand wash it, and dry it thoroughly.
- Plug the refrigerator back in.

OUTSIDE

Wax the outside in order to create better protection. Make sure you use a product specifically design to be used for electro-domestic products (car wax is acceptable). Use a clean, soft rag, and perform this task twice a year. For metal-made refrigerators, do not wax, simply clean it with water and detergent. Do not use concentrated or abrasive products.

In case of STS, apply cleaner in same direction that hair line of STS.

NOTE: Avoid the usage of chemical products that contain phosphates or bleach.

INSIDE (Allow freezer to slightly warm up a small degree to prevent cloth from sticking)

In order to eliminate bad odors, clean the inside of the refrigerator with a mixture of baking powder and lukewarm water (one teaspoon of baking powder per cup of water). Ensure that the powder dissolves thoroughly, in order to prevent any sort of damage.

DOOR LINING AND GASKETS

Use only a mild detergent (such as dish soap).

PLASTIC PARTS (Covers and Panels)

Do not use abrasive, paper or rough products. These could damage the product.

BACK COVER

⚠ WARNING

ELECTRICAL SHOCK HAZARD

Before you begin, either unplug the refrigerator or turn off power at the circuit breaker or fuse box.

NOTE: Back Cover should only be removed by a qualified technician.

In order to get an efficient performance of your refrigerator, clean the back cover of it at least twice a year.

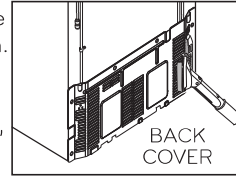

REPLACING REFRIGERATOR LIGHTS

The refrigerator and freezer compartment lights are LED interior lighting, and service should be performed by a qualified technician.

⚠ WARNING

ELECTRIC SHOCK HAZARD

Before replacing a burned-out light bulb, either unplug the refrigerator or turn off power at the circuit breaker or fuse box.

POWER INTERRUPTIONS

1. In case of a black out, call your electric company and ask how long it will last.
2. In case of a 24 hour or less black out, do not open the refrigerator; this will keep the food fresh.
3. In case of a longer black out, do one of the following options:
 - Pull out all of the frozen food and keep them in an ice chest.
 - Put 2 lbs (907 g) of frozen ice (make sure you use gloves) for each square foot (28 L) inside the freezer. This task will preserve the food from 2 to 4 days.
 - In case you do not possess neither ice chest or dry ice, consume your food as soon as possible.

REMEMBER: In a power failure, a full freezer stays cold longer than a partially filled one. A freezer full of meat stays cold longer than a freezer full of baked goods. If you see that food contains ice crystals, it may be safely refrozen, although the quality and flavor may be affected. If the condition of the food is poor or if you feel it unsafe, dispose of it.

WHEN GOING ON VACATION

If you decide to leave your refrigerator on when going away, consider these steps:

1. Consume all of the perishable items and freeze the rest.
2. Empty the ice bin.

If you decide to leave your refrigerator off:

1. Remove all of the food.
2. Unplug your refrigerator.
3. Clean and dry it well.
4. Make sure the doors stay open (use blocks or tape) in order to prevent bad odors and fungi from happening.

REFRIGERATOR CARE AND CLEANING

WHEN MOVING

If you decide to take your refrigerator with you when moving, consider the following:

1. Remove all of the food from it, and place the frozen food in an ice chest with dry ice.
2. Unplug your refrigerator.
3. Empty the water from its tray.
4. Clean and dry it with a rag.
5. Pull out all of the removable parts, and wrap them with adhesive tape.
6. Depending on the model of the refrigerator, lift the top part of the refrigerator so it can roll with ease, or screw the levelers so it won't scratch the floor. Consult to the section "**Closing and Aligning Doors**".

7. Keep the doors closed with the cable glued to the refrigerator cabinet with an adhesive tape.

When your refrigerator arrives to your home, put everything back into place and read the section "**Refrigerator Installation**" in order to obtain installation preparation. In case your refrigerator has a factory ice maker, remember you have to reconnect the water supply.

ABOUT THE AUTOMATIC ICE MAKER

NOTE: The automatic Ice maker is only included in some models. Check your specifications of your refrigerator.

⚠ WARNING

PERSONAL INJURY HAZARD

Avoid contact with any moving parts of the ejector mechanism or with the heater that releases the ice cubes. **DO NOT** place your fingers in the automatic ice maker when the refrigerator is plugged in.

OPERATING INSTRUCTIONS

After turning on your refrigerator, the ice will start to be made between 12 and 24 hours.

Identify your ice maker type.

Type 1

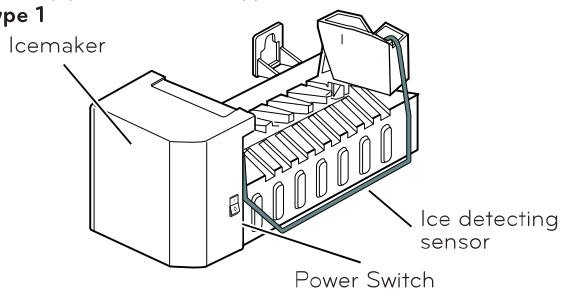

The ice maker produces 8 cubes per cycle (between 64 and 128 cubes in a 24 hour period), depending on the temperature of the freezer, the times in which the door opens, and other using conditions (amount of food in the freezer, etc).

If the refrigerator is used before the connection of water to the ice maker was performed, you must turn its dial to **O** (off).

When the water connections are performed, turn its dial to **I** (on).

The ice maker will fill up (and start making ice) between 12 and 24 hours after the refrigerator is turned on.

Throw away the first batch of ice. Make sure that nothing interferes with the sensor.

When the ice reaches the sensor, the ice maker will stop to make ice immediately.

It's normal that some ice gets stuck. If the ice is not used frequently, the older cubes of ice will be opaque in color, smaller, and with a strange flavor.

NOTE: Never store beverage cans or other items in the ice bin for the purpose of rapid cooling. Doing so may damage the ice maker or the container may burst.

YOU MUST TURN THE SWITCH TO O (OFF)

- When the water supply is interrupted for many hours.
- When the ice container is left out of its place for more than one or two minutes.
- When the refrigerator will not be in use for various days.

NORMAL SOUNDS

- The valve will emit a buzzing sound when the ice maker is full of water. If the switch is placed in the on position the buzz will still be heard even when the water pipe has not been connected. To avoid this sound, move switch to **O** (off) position.

NOTE: The ice maker can get damaged if the switch is kept in the ON position before the water pipe has been connected.

- While the ice maker is filling up with water and producing ice, you will hear the sound of the ice falling and water flowing through the pipes.
- You will hear the sound of cubes dropping into the bin and water running in the pipes as the icemaker refills.

PREPARING FOR VACATIONS

Move the ice maker switch to the **O** (off) position and cut the flow of water going into the refrigerator.

If room temperature is at freezing point, have a specialized technician drain the flow of water from the inner pipes (certain models) to avoid broken pipe related damage.

NOTE: To avoid water spilling, the unit should be leveled and placed on even floor. Do not remove the ice bin from the ice maker for a long period, doing so may cause ice spilling.

CONNECTING THE WATER LINE

NOTE: It is necessary to have a water source when both water and/or ice dispensers are available in your product. Check the specifications and model of your refrigerator.

BEFORE START

The water source is not guaranteed by the refrigerator manufacturer. Follow instructions carefully in order to reduce damage.

Air located inside the water pipes can cause hammering or tapping causing damage to the inner pipes or water spillage in the inside of the refrigerator. Call a qualified plumber to fix such hammering on the connections before installing the water pipe.

To avoid burn damage or such, never connect refrigerator to hot water pipes.

If you are to use the refrigerator before connecting it to the water source, make sure the ice maker is the off position.

Never attempt to install the ice maker pipes in areas where room temperature is below freezing point.

When using any electrical device (like a drill) during the installation, make sure device is doubly isolated or making ground to prevent risk of electrical surge or discharge.

All installations should be done considering local water and drainage requirements.

- If an inverted osmosis water filtration system is connected to the cold water source, the water hose installation is not assured or guaranteed by the refrigerator or automated ice maker manufacturer. Follow the next instructions carefully to minimize costly water related damages.
- When having an inverted osmosis water filtration system connected to the cold-water flow, the water pressure for such system must be at least between 40-60 PSI or 0,27 MPa ($2,8 \text{ kg} \cdot \text{f} / \text{cm}^2 \sim 4,2 \text{ kg} \cdot \text{f} / \text{cm}^2$, ($2,8 \text{ kg} \cdot \text{f} / \text{cm}^2 \sim 4,2 \text{ kg} \cdot \text{f} / \text{cm}^2$, less than 2 ~ 3 seconds to fill a 7 oz of capacity cup [0,2 liters]).
- If the inverted osmosis water filtration system pressure is less than 21 PSI or 0,14 MPa ($1,5 \text{ kg} \cdot \text{f} / \text{cm}^2$, more than four (4) seconds to fill a 7 oz of capacity cup [0,2 liters]):

- a) Identify if the sediments filter in the inverted osmosis system is being blocked. Replace filter if necessary.
- b) Allow inverted osmosis system storage tank to refill after extensive usage.
- c) Call a qualified plumber if the inverted osmosis water pressure problem continues.

REQUIREMENTS

- **1/4" (6,35 mm) in diameter copper pipe** to connect refrigerator to the water pipe. Make sure both terminals are cut in a squared manner.

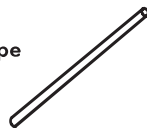

To determine how much pipe material is needed, measures the distances between the valves located

behind the refrigerator and the source of water and add to that 8 feet (2,4 m). Make sure there is sufficient pipe material to allow the free movement of the refrigerator from the wall

- **A cold water source.** Water pressure should be between 0,138 and 0,82 MPa or 20 and 120 PSI for models not containing water filter and between 0,276 and 0,82 MPa or 40 and 120 PSI for models containing water filter.

- **A drill.**

- **Adjustable 1/2" (12,7 mm) key.**

- **Flat and Phillips style (star) screwdriver.**

- **Two 1/4" (6,35 mm) diameter compression nuts** with two sides to connect the copper pipe to the refrigerator valve.

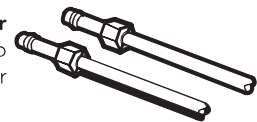
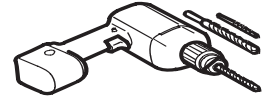

If your current copper pipe has some reduction on the ends, it will be necessary to get an adaptor (found in hardware stores) to connect the water line to the refrigerator. It is also possible to cut such reductions with a pipe cutter and use the compression connections mentioned above.

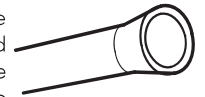

- **Bypass valve** to connect to the cold water line. The valve must have a water opening with an interior 5/32" (3,46 mm) diameter in the cold-water connection point. These valves can be located in any cold-water connection package. Before buying make sure such valve meets local standards and requirements.

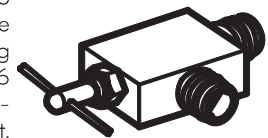

INSTALLATION INSTRUCTIONS

Install the valve to the pipe that you use to drink water.

⚠ CAUTION: Connect to potable water supply only.

1. CLOSE THE MAIN WATER SOURCE

Open the nearest water faucet to let water flow and empty pipes.

2. SELECT THE LOCATION OF THE VALVE

Select the location of the valve that will provide a better access. It is best to connect to a vertical pipeline. When connecting to a horizontal pipeline is necessary, make the connection in the lateral or upper area instead of the lower area to prevent accumulation of sediment.

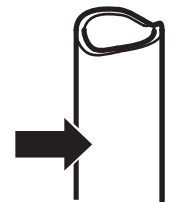

CONNECTING THE WATER LINE

3. DRILL A HOLE FOR THE VALVE

Drill a 1/4" (6,35 mm) diameter hole in the water pipeline. Remove jagged edges produced after perforation. Make sure water does not reach the drill. Not performing the 1/4" (6,35 mm) perforation can lead to a low or smaller ice production.

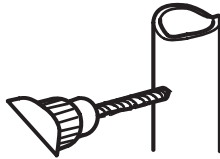

4. TIGHTEN THE VALVE

Tighten the valve into the cold water pipeline with a tube trap.

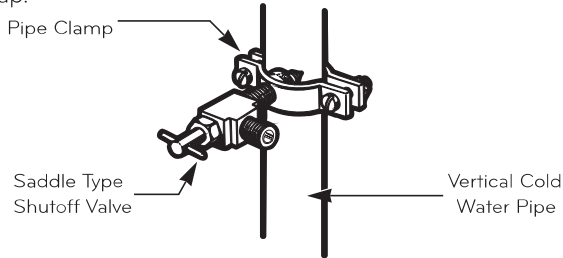

NOTE: Codes for 248 CMR pipelines of the state of Massachusetts must be attached to the connection. Valves of this type are banned in Massachusetts. Call an authorized plumber by the norms and regulations of your country.

5. TIGHTEN THE TRAP

Tighten the trap until the sealing ring begins to grow.

NOTE: Make sure it is not too tight, this can break the pipe.

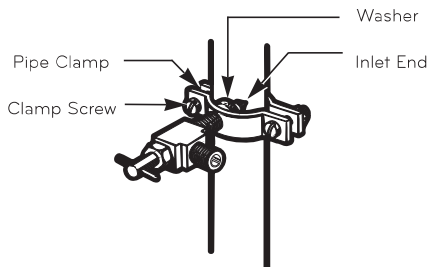

6. PLACE THE PIPELINE

Place the pipeline between the cold water pipe and the refrigerator. Place it through a hole in the wall or floor (behind the refrigerator or next to the cabinet) as close to the wall as possible.

NOTE: Make sure there is a sufficient amount of extra pipeline (8 feet [244 mm] coiled up three times with a 10" [25 cm] in diameter) to allow free movement of the refrigerator from the wall after installation was made.

7. CONNECT PIPELINE TO VALVE

Place the compression nut and the copper pipe ferule at the end of the pipe and connect to the valve. Make sure the pipe is completely inserted into the valve. Tighten nut carefully.

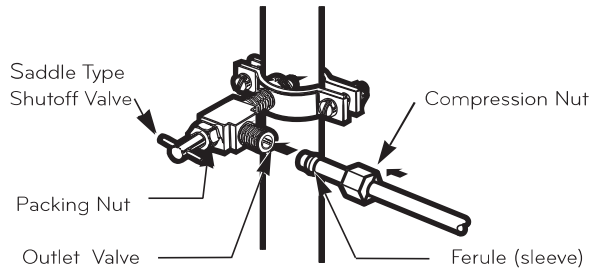

8. DRAIN THE PIPE

Open the main water source (1) and drain the pipe until water comes out clear.

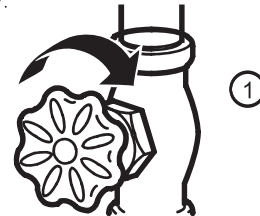

Allow water flow from the bypass valve (2) and close after draining 1/4 of a gallon (1L) of water.

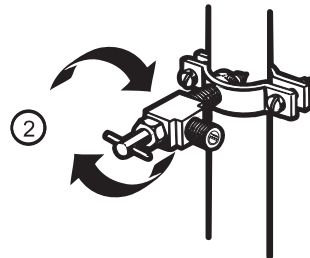

9. CONNECT PIPE TO REFRIGERATOR

NOTES:

- Before making connection to refrigerator, make sure it is not connected to any energy source. If your refrigerator does not have a water filter, it is advised to install one.
- If your water source contains sand or related particles that can travel to the valve, install a water filter near the refrigerator.

IMPORTANT: Never use old or used hoses. Always use new ones to have a better use and experience. Connect always to a potable water source to avoid security and health issues.

- Remove the ring plug (1) from the valve located at the top of such device.

